

The history of revision change for the specification

Document	REV.	Modified date	Description
CYNVC-205-046	A0	2020.5.22	New approval
CYNVC-205-046	A1	2020.9.6	1. May -> Sep. 2. Update Land Pattern B: 3.3 -> 2.8 3. Add spec R47, 4R7, 6R8, 220, 330, 470 4. Remove spec 101
CYNVC-205-046	A2	2020.9.21	Update 470 DCR(Typ.): 177 -> 203 ; DCR(Max.): 212 -> 225
CYNVC-205-046	A3	2020.10.05	1. Sep. -> Oct. 2. Update 470 DCR(Max.): 225 -> 240 3. Add curve R47, 220
CYNVC-205-046	A4	2020.10.20	1. Update 6R8 DCR(Typ.): 30.3 -> 33.0 ; DCR(Max.): 36.0 -> 39.6 ; Idc(Typ.): 5.4 -> 5.2 ; Idc(Max.): 4.9 -> 4.7 2. Update 330 DCR(Typ.): 132 -> 121 ; Idc(Max.): 2.3 -> 2.4
CYNVC-205-046	A5	2020.11.13	1. Oct. -> Nov. 2. Update 4R7 Isat(Max.): 12.1 -> 11.2 3. Update 330 Isat(Max.): 3.8 -> 3.5
CYNVC-205-046	A6	2020.12.23	1. Nov. -> Dec. 2. Update Outline Dimensions H: 0 ~ + 0.15 -> 0.05 ~ 0.20 3. Add spec 3R3, 100, 150, 101 4. Add curve 470, 680
CYNVC-205-046	A7	2020.12.28	Update Outline Dimensions H: 0.05 ~ 0.20 -> 0.05 Min.
CYNVC-205-046	A8	2021.3.19	1. Dec., 2020 -> Mar., 2021 2. Remove Notice "Preliminary specification" 3. Add notice "Compliance with AEC-Q200" in Features 4. Add curve R22, 3R3, 4R7, 6R8, 150
CYNVC-205-046	A9	2021.6.11	1. Mar. -> Jun. 2. Add spec 1R0 3. Add curve 100, 330, 101
CYNVC-205-046	B0	2021.7.23	Add Rated Voltage
CYNVC-205-046	B1	2021.12.13	1. Jul. -> Dec. 2. Remove Notice "Compliance with AEC-Q200" in Features 3. Add notice "AEC-Q200 qualified" in Features 4. Add "AEC-Q200" logo
CYNVC-205-046	B2	2022.4.22	1. Dec., 2021 -> Apr., 2022 2. Add spec 1R5, 2R2
CYNVC-205-046	B3	2023.4.10	1. Apr., 2022 -> Apr., 2023 2. Add Multi-Layer Idc spec 3. Add Note 4. Idc : DC current (A) that will cause an approximate ΔT of 40 °C (Multi-Layer PCB) 4. Update curve (Single-Layer -> Multi-Layer)
CYNVC-205-046	B4	2023.6.16	1. Apr -> Jun 2. Remove Multi-Layer Idc spec 3. Add spec of 8R2 4. Remove Note 4. Idc : DC current (A) that will cause an approximate ΔT of 40 °C (Multi-Layer PCB) 5. Update curve (Multi-Layer -> Single-Layer)

AEC-Q200

Power Choke Coil VCUW064E MS5 type

■ Features

High performance (Isat) realized by metal dust core.

Low profile : Thickness max. 4.5mm

Low loss realized with low DCR

Capable of corresponding high frequency

Compliance with RoHS and Halogen Free

AEC-Q200 qualified

■ Application

Automotive applications

■ Outline Dimensions

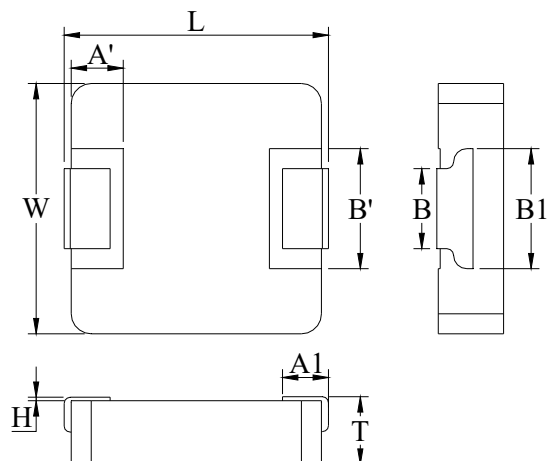

Code	Dimensions (mm)
L	6.95 ± 0.35
W	6.6 ± 0.2
T	4.3 ± 0.2
A1	1.5 ± 0.3
A'	2.6 ± 0.1
B	3.0 ± 0.3
B1	4.3 ± 0.3
B'	3.6 ± 0.2
H	0.05 Min.

■ Recommend Land Pattern Dimensions

The customer shall determine the land dimensions shown below after confirming and safety.

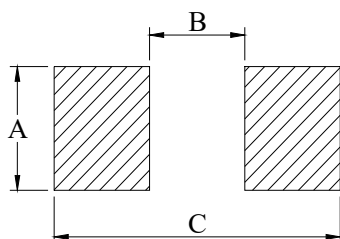

A	3.5
B	2.8
C	8.4

Unit : mm

■ **Marking and Date Code**

The point on the top surface represents winding direction of choke.

(1) **Marking**

The inductor is marked with a 3-digit code

Example -- 0.22 μ H → R22

(2) **Date Code**

X XX

(1) (2)

XXX

(3)

Where (1) Year Code

Ex : 2023 = 3

(2) Weekly Code

Serial number : 01 ~ 53

(3) Taping No.

Serial number : 001 ~ ZZZ

Upside of Chip

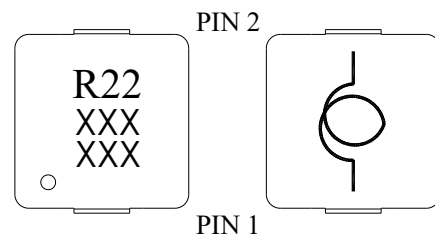

■ Specifications

Part Number	L0 ◇ Inductance (μ H) @ (0A)	R _{dc} (m Ω) ◇		Heat Rating Current DC Amps. Idc (A)		Saturation Current DC Amps. Isat (A)		Rated Voltage (V)
		Typical	Maximum	Typical	Maximum	Typical	Maximum	Maximum
VCUW064E-R22MS5	0.22	2.0	2.4	22.2	20.0	57.2	49.0	70
VCUW064E-R47MS5	0.47	3.0	3.6	18.1	16.3	25.0	21.0	70
VCUW064E-1R0MS5	1.0	5.2	6.2	13.3	12.0	23.9	16.5	70
VCUW064E-1R5MS5	1.5	6.7	8.1	11.6	10.4	19.7	15.0	70
VCUW064E-2R2MS5	2.2	9.5	11.4	9.8	8.8	19.4	14.0	70
VCUW064E-3R3MS5	3.3	15.7	18.8	7.6	6.8	17.7	13.5	70
VCUW064E-4R7MS5	4.7	20.2	24.2	6.7	6.1	14.8	11.2	70
VCUW064E-6R8MS5	6.8	33.0	39.6	5.2	4.7	12.1	10.1	70
VCUW064E-8R2MS5	8.2	40.0	48.0	5.0	4.5	10.2	8.8	70
VCUW064E-100MS5	10.0	47.9	57.5	4.3	3.9	9.6	8.2	70
VCUW064E-150MS5	15.0	66.0	79.2	3.7	3.4	6.2	5.3	70
VCUW064E-220MS5	22.0	86.7	104.0	3.2	2.9	5.2	4.1	70
VCUW064E-330MS5	33.0	121.0	145.2	2.7	2.4	4.4	3.5	70
VCUW064E-470MS5	47.0	203.0	240.0	2.3	2.1	4.2	3.3	70
VCUW064E-680MS5	68.0	312.0	374.0	1.8	1.6	3.9	3.0	70
VCUW064E-101MS5	100.0	413.0	496.0	1.50	1.35	2.4	2.1	70

◇ : Significant Characteristic

* : If you require another part number please contact with us.

** : Inductance Tolerance \pm 20%

Note 1. : All test data is referenced to 25°C ambient.

Note 2. : Test Condition: 100KHz, 1.0Vrms

Note 3. : Idc : DC current (A) that will cause an approximate Δ T of 40°C (Single-Layer PCB)

Note 4. : Isat : DC current (A) that will cause L0 to drop approximately 30%

Note 5. : Operating Temperature Range -55°C to +155°C

Note 6. : The part temperature (ambient + temp rise) should not exceed 155°C under the worst case operating conditions. Circuit design, component placement, PCB trace size and thickness, airflow and other cooling provision all affect the part temperature. Part temperature should be verified in the end application.

Note 7. : The rated current as listed is either the saturation current or the heating current depending on which value is lower.

Note 8. : Cleaning Process Note

(a) If this power choke is dipped in the cleaning agent, such as toluene, xylene, ketone, and ether system, there is a possibility that the performance decreases greatly

(b) The high power ultrasonic washing may damage the choke body.

(c) Please contact us if you need the cleaning via the above agents or ultrasonic washing.

Current Characteristic

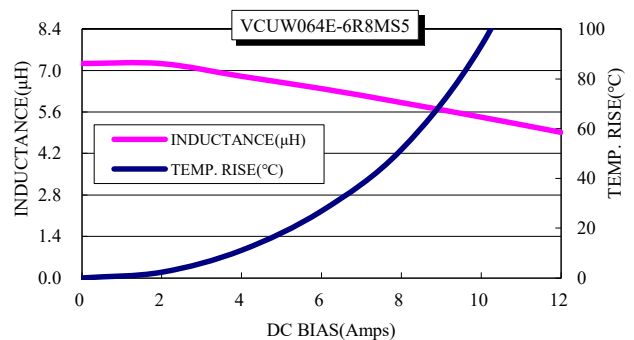
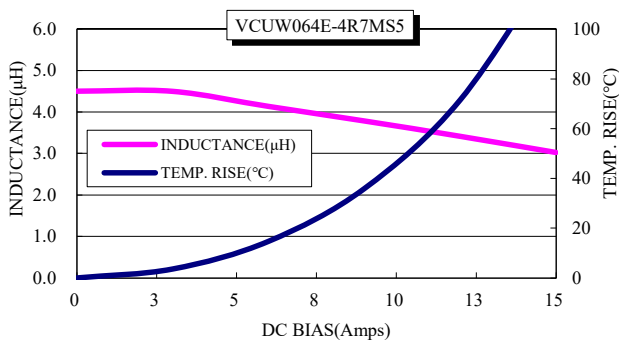
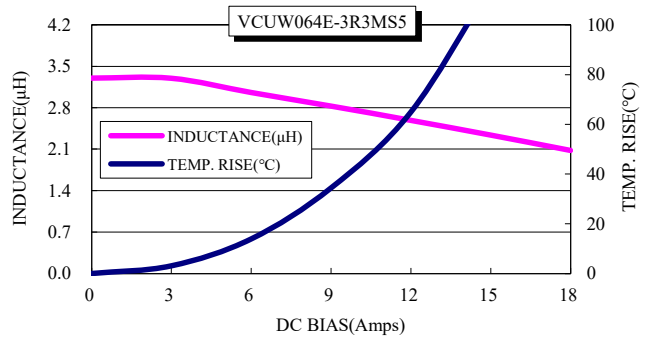
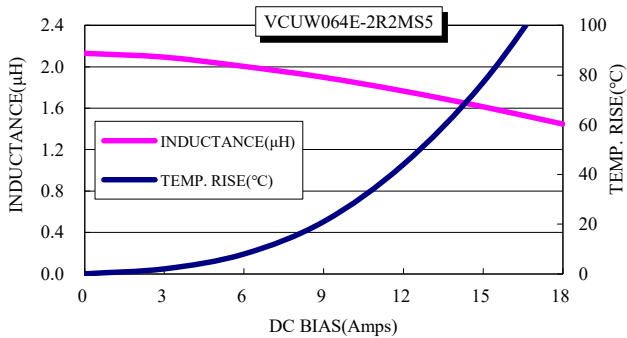
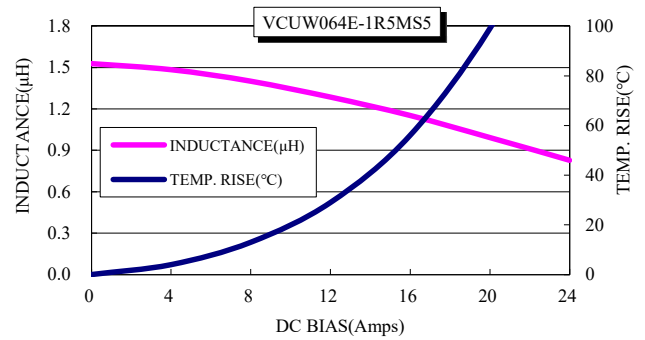
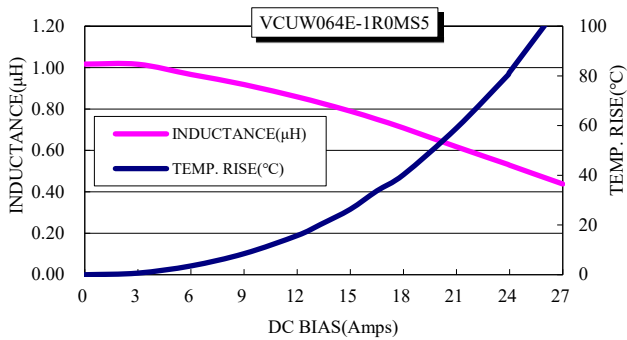
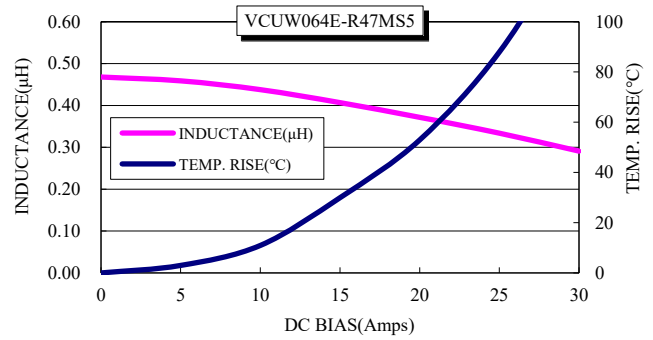
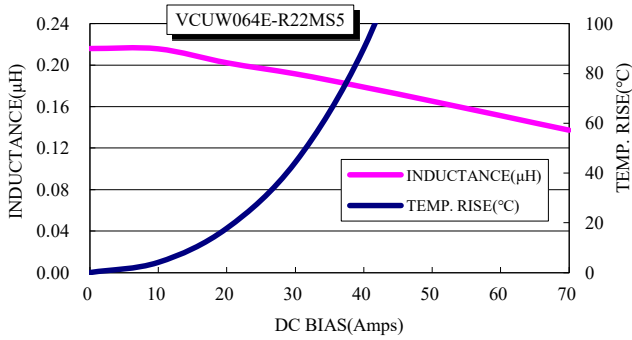

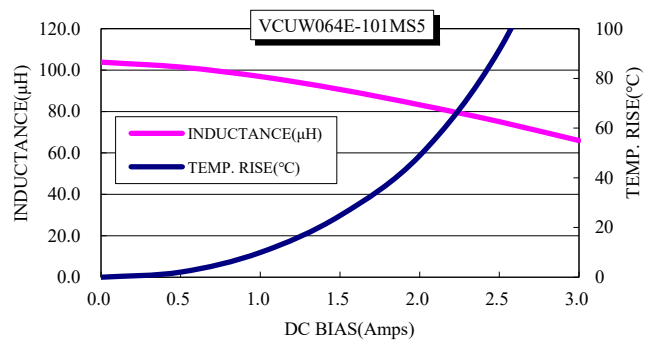
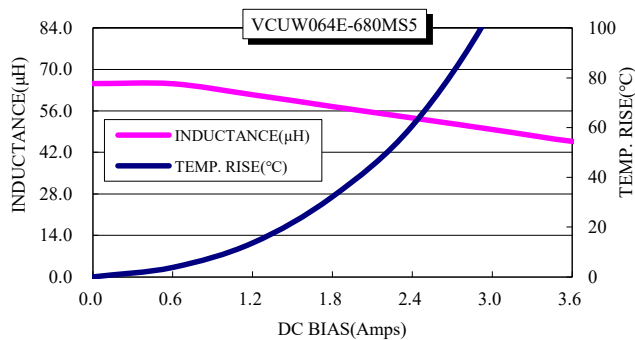
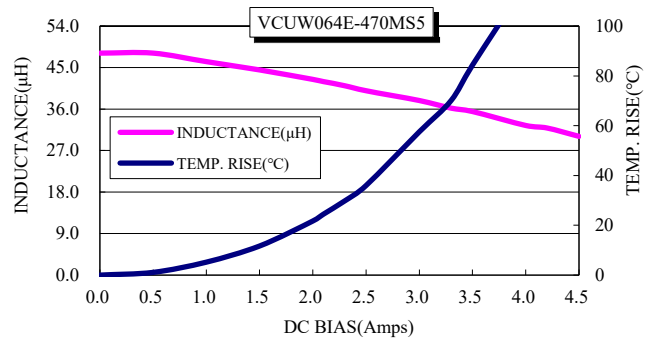
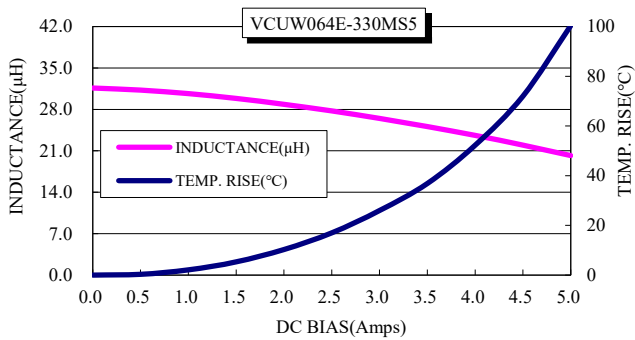
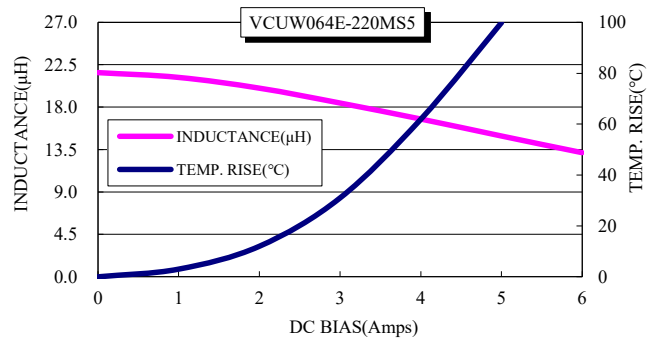
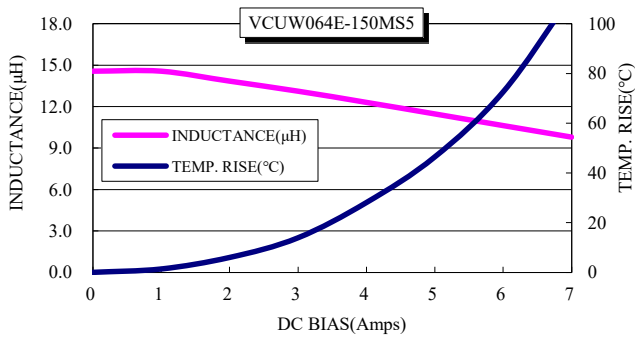
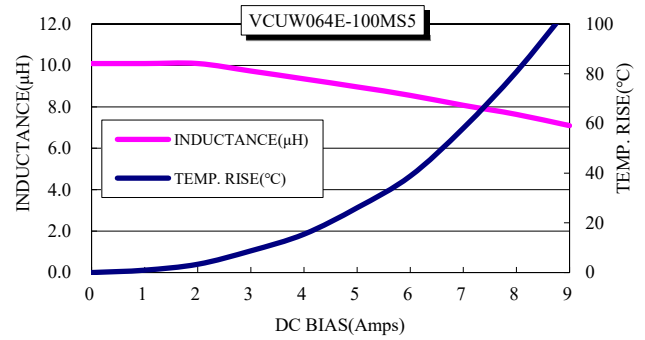
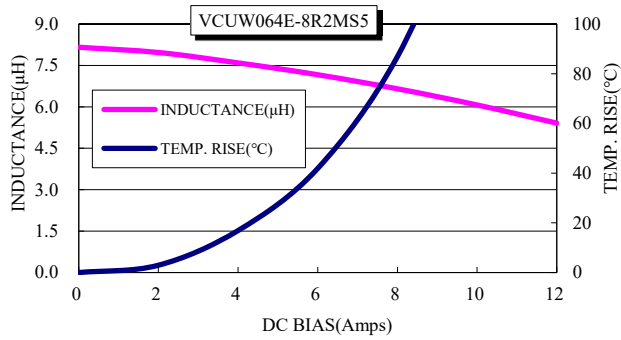

■ Packaging

(1) Tape packaging dimensions

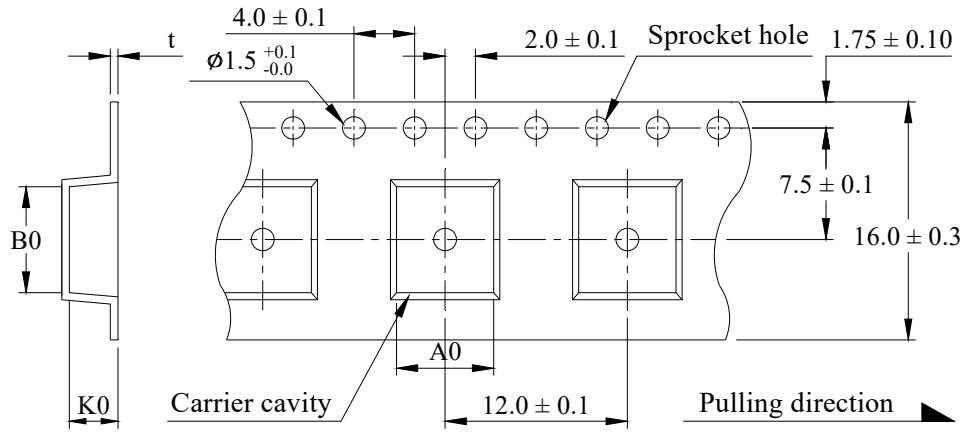

Dimensions Code (mm)				UNITS/REEL
A0	B0	K0	t	
7.0 ± 0.1	7.4 ± 0.1	5.1 ± 0.1	0.50 ± 0.05	500

(2) Tape Direction

The direction shall be seen from the top cover tape side.

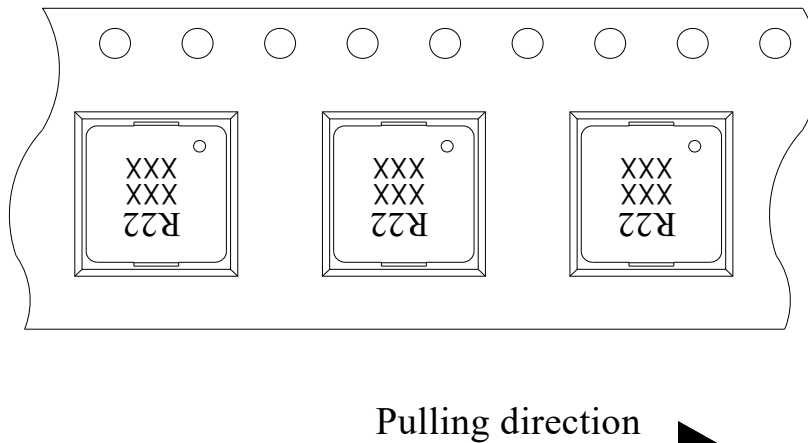

(3) Reel dimensions

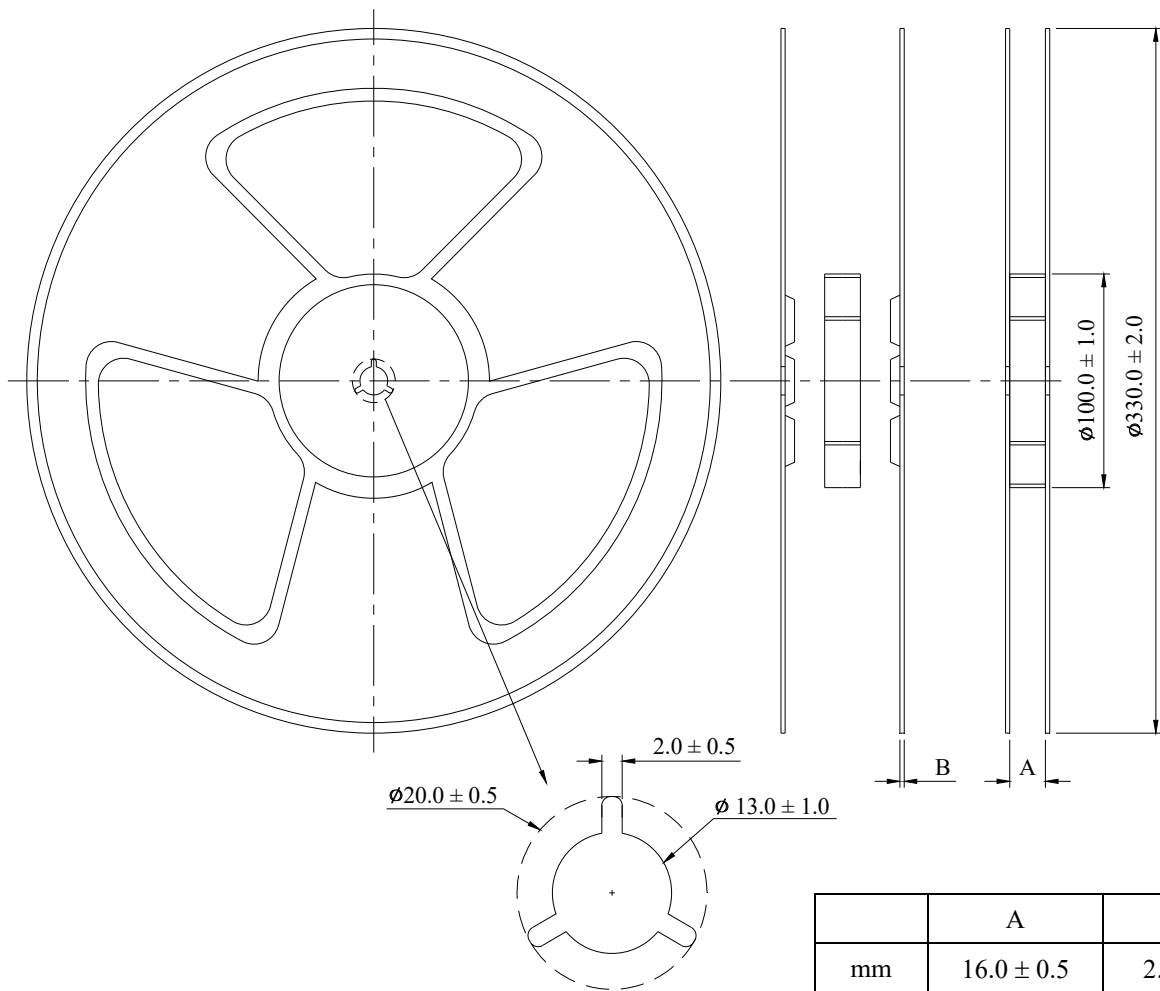

(4) Peel force of top cover tape

The peel speed shall be about 300 mm/minute.

The peel force of top cover tape shall be between 0.1 to 1.3N.

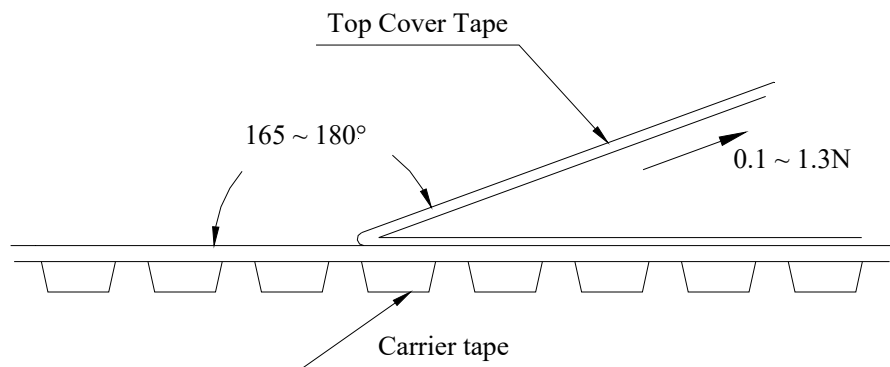

■ Reflow Profile

Power Choke Coil Type

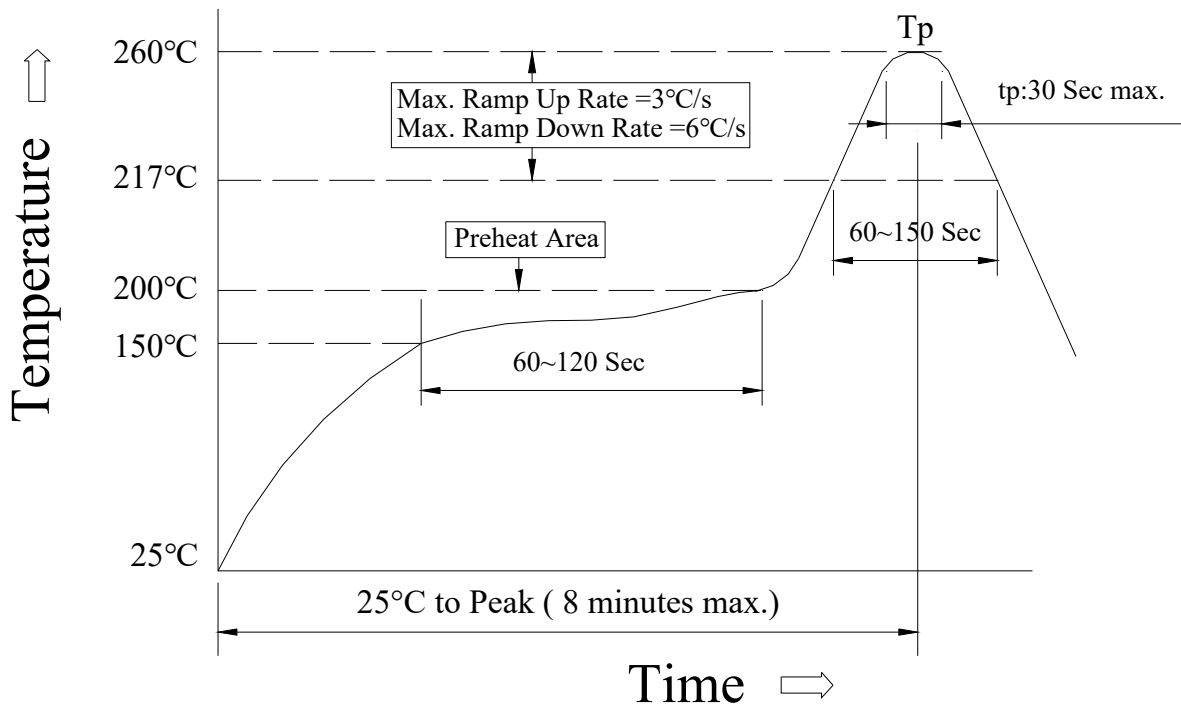

(1) Reflow Soldering Method :

Reflow Soldering	Tp:255~260°C	Max.30 seconds (tp)
	217°C	60~150 seconds
Pre-Heat	150 ~ 200°C	60~120 seconds
Time 25°C to peak temperature	8 minutes max.	

(2) Soldering iron Method : 350 ± 5°C max.3 seconds