

The history of revision change for the specification

Document	REV.	Modified date	Description
CYNVA-175-002	A0	2017.5.24	New Approval
CYNVA-175-002	A1	2017.6.20	1. May -> Jun. 2. Add spec of 5R0 ; add curve of 5R0
CYNVA-175-002	A2	2018.6.6	1. Add notice "AEC-Q200 qualified" in Features 2. Add "AEC-Q200" logo on page 2 3. Remove notice "Preliminary specification" 4. Year code 2017 = 7 -> 2018 = 8
CYNVA-175-002	A3	2019.4.29	1. Jun., 2018 -> Apr., 2019 2. Year code 2018 = 8 -> 2019 = 9 3. Remove spec of 5R0 ; remove curve of 5R0
CYNVA-175-002	A4	2019.10.3	1. Apr. -> Oct, 2. Remove 8R2 spec and curve.
CYNVA-175-002	A5	2020.1.20	1. Oct., 2019 -> Jan., 2020 2. Year Code: 2019 = 9 -> 2020 = 0 3. Remove frequency: (1MHz) from Features 4. Add 6R8 spec and curve
CYNVA-175-002	A6	2021.8.2	1. Jan., 2020 -> Aug., 2021 2. Year code: 2020 = 0 -> 2021 = 1 3. Add Rated voltage (V): 75V
CYNVA-175-002	A7	2023.05.09	1. Aug., 2021 -> May., 2023 2. Year code: 2021 = 1 -> 2023 = 3 3. Add 3R3 spec and curve

### Power Choke Coil VAMV08089A MM2 type

AEC-Q200

#### ■ Features

High performance (Isat) realized by metal dust core.

Low profile : Thickness max. 9.1mm

Low loss realized with low DCR

Capable of corresponding high frequency

Compliance with RoHS and Halogen Free

AEC-Q200 qualified

#### ■ Application

Automotive applications

#### ■ Outline Dimensions

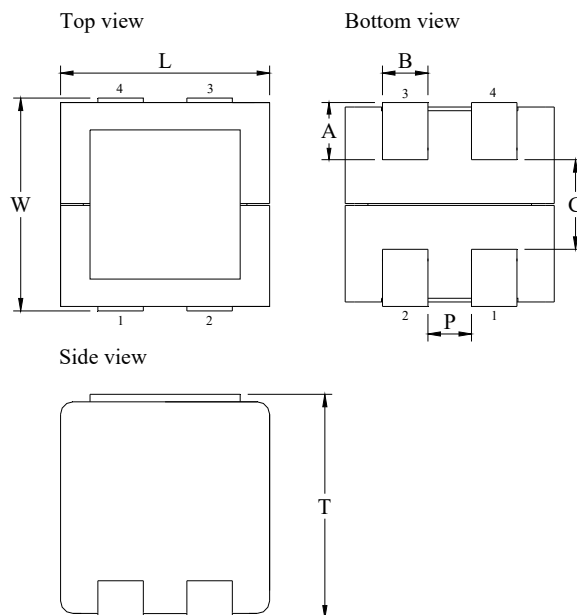

Code	Dimensions (mm)
L	8.15 ± 0.20
W	8.0 ± 0.2
T	8.9 ± 0.2
A	2.3 ± 0.2
B	1.95 ± 0.20
C	3.2 typ.
P	1.9 ± 0.2

#### ■ Schematic

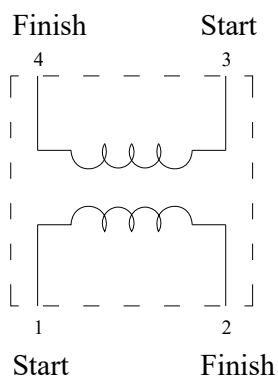

### ■ Recommend Land Pattern Dimensions

The customer shall determine the land dimensions shown below after confirming and safety.

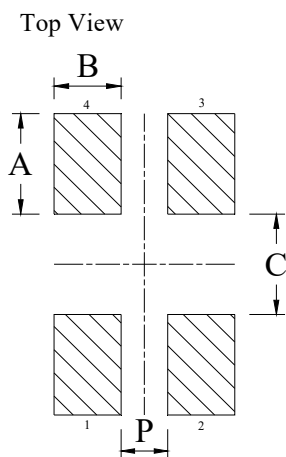

A	3.5
B	2.3
C	3.5
P	1.6

Unit : mm

### ■ Marking and Date Code

#### (1) Marking

The inductor is marked with a 3-digit code

Example -- 10.0 $\mu$ H → 100

#### (2) Date Code

X    XX

(1)    (2)

XXX

(3)

Where (1) Year Code

Ex : 2023 = 3

(2) Weekly Code

Serial number : 01 ~ 53

(3) Taping No.

Serial number : 001 ~ ZZZ

#### Upside of Choke

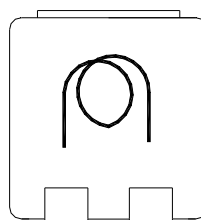
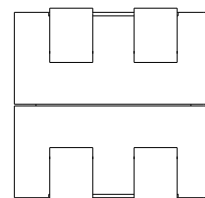
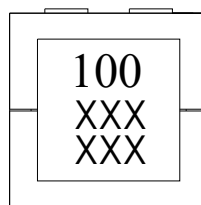

### ■ Specifications

Part Number	L0 ◇ Inductance ( $\mu$ H) @ (0A)	R <sub>dc</sub> ( m $\Omega$ ) ◇		Heat Rating Current DC Amps. Idc ( A )		Saturation Current DC Amps. Isat ( A )		Rated Voltage ( V )
		Typical	Maximum	Typical	Maximum	Typical	Maximum	Maximum
VAMV08089A-3R3MM2	3.3	13.2	15.8	6.3	5.6	16.8	14.4	75
VAMV08089A-6R8MM2	6.8	23.5	28.2	4.7	4.2	9.6	8.2	75
VAMV08089A-100MM2	10.0	33.0	40.0	4.0	3.6	8.0	6.8	75
VAMV08089A-150MM2	15.0	57.0	68.4	3.0	2.7	6.6	5.6	75
VAMV08089A-220MM2	22.0	88.0	105.0	2.4	2.2	4.6	3.9	75

◇ : Significant Characteristic

\* : If you require another part number please contact with us.

\*\* : Inductance Tolerance  $\pm$  20%

Note 1. : All test data is referenced to 25°C ambient.

Note 2. : MS Level: Level 1.

Note 3. : Test Condition:100KHz, 1.0Vrms

Note 4. : Idc : DC current (A) that will cause an approximate  $\Delta$ T of 40°C

Note 5. : Isat : DC current (A) that will cause L0 to drop approximately 25%

Note 6. : Operating Temperature Range -55°C to + 125°C

Note 7. : The part temperature (ambient + temp rise) should not exceed 125°C under the worst case operating conditions. Circuit design, component placement, PCB trace size and thickness, airflow and other cooling provision all affect the part temperature. Part temperature should be verified in the end application.

Note 8. : The rated current as listed is either the saturation current or the heating current depending on which value is lower.

Note 9. : Cleaning Process Note

(a) If this power choke is dipped in the cleaning agent, such as toluene, xylene, ketone, and ether system, there is a possibility that the performance decreases greatly

(b) The high power ultrasonic washing may damage the choke body.

(c) Please contact us if you need the cleaning via the above agents or ultrasonic washing.

### Current Characteristic

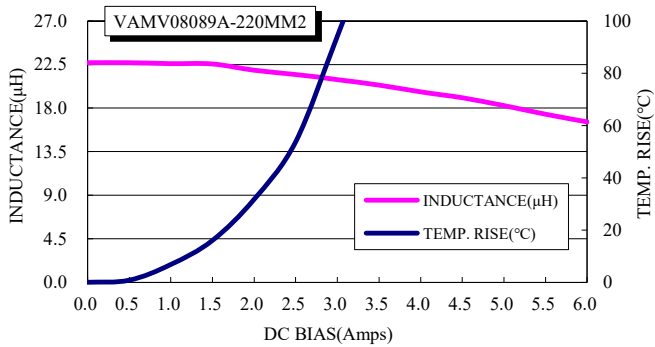
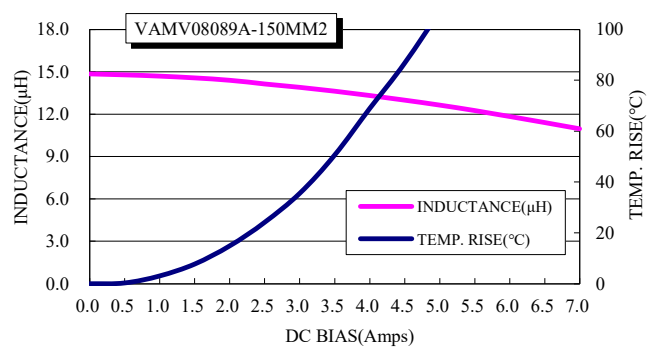
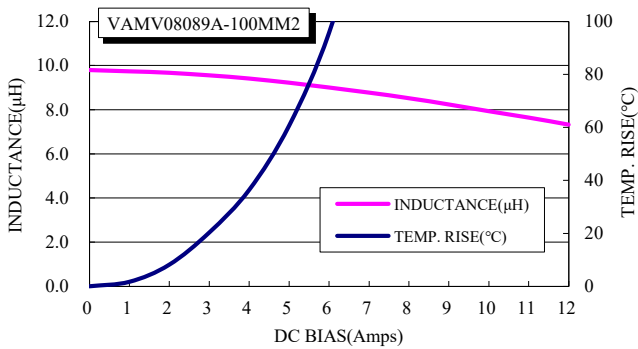
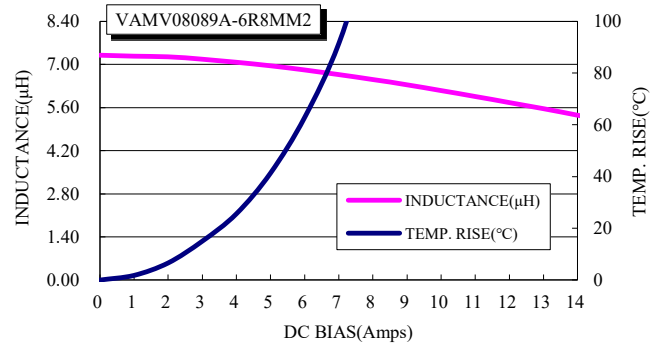
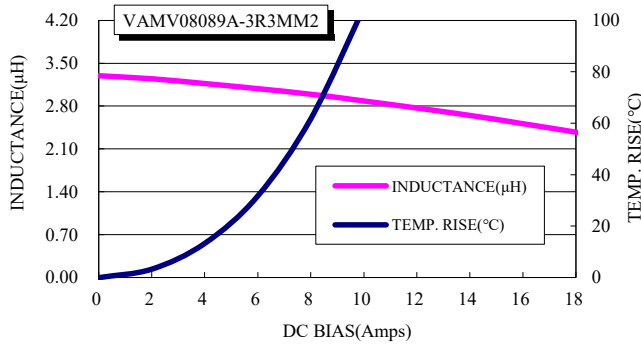

### ■ Packaging

#### (1) Tape packaging dimensions

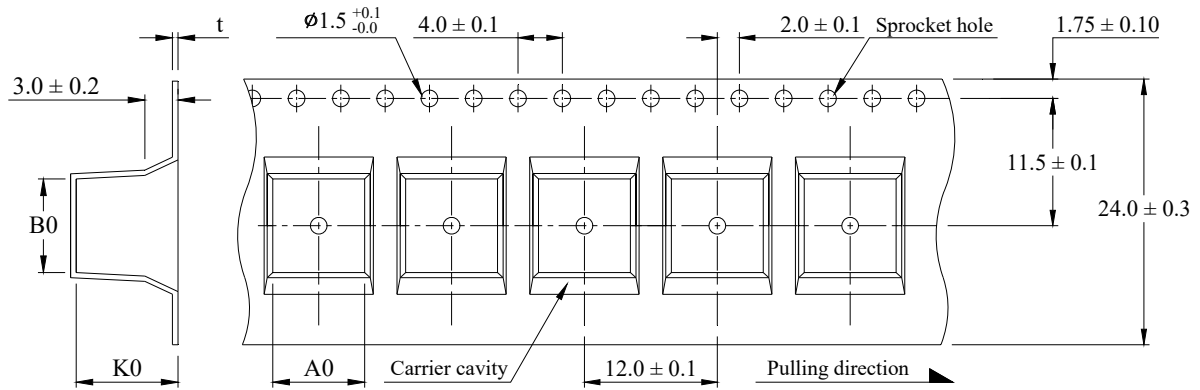

Dimensions Code (mm)				UNITS/REEL
A0	B0	K0	t	
$8.3 \pm 0.1$	$8.45 \pm 0.10$	$9.2 \pm 0.1$	$0.50 \pm 0.05$	500

#### (2) Tape Direction

The direction shall be seen from the top cover tape side.

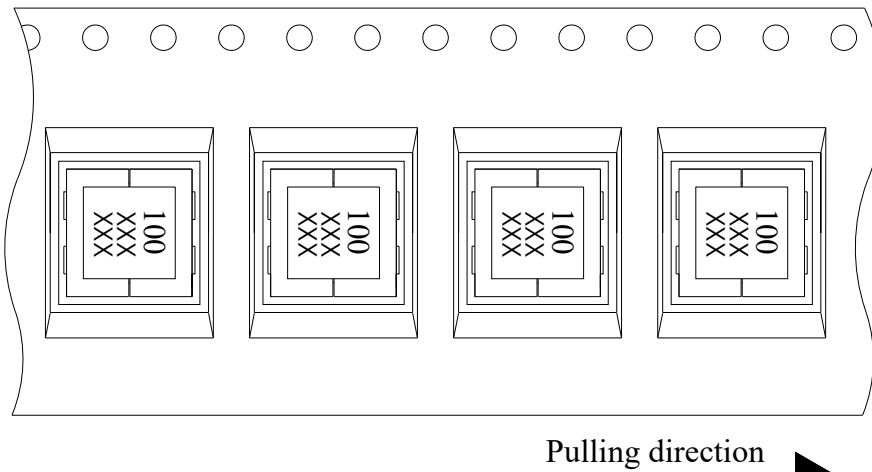

(3) Reel dimensions

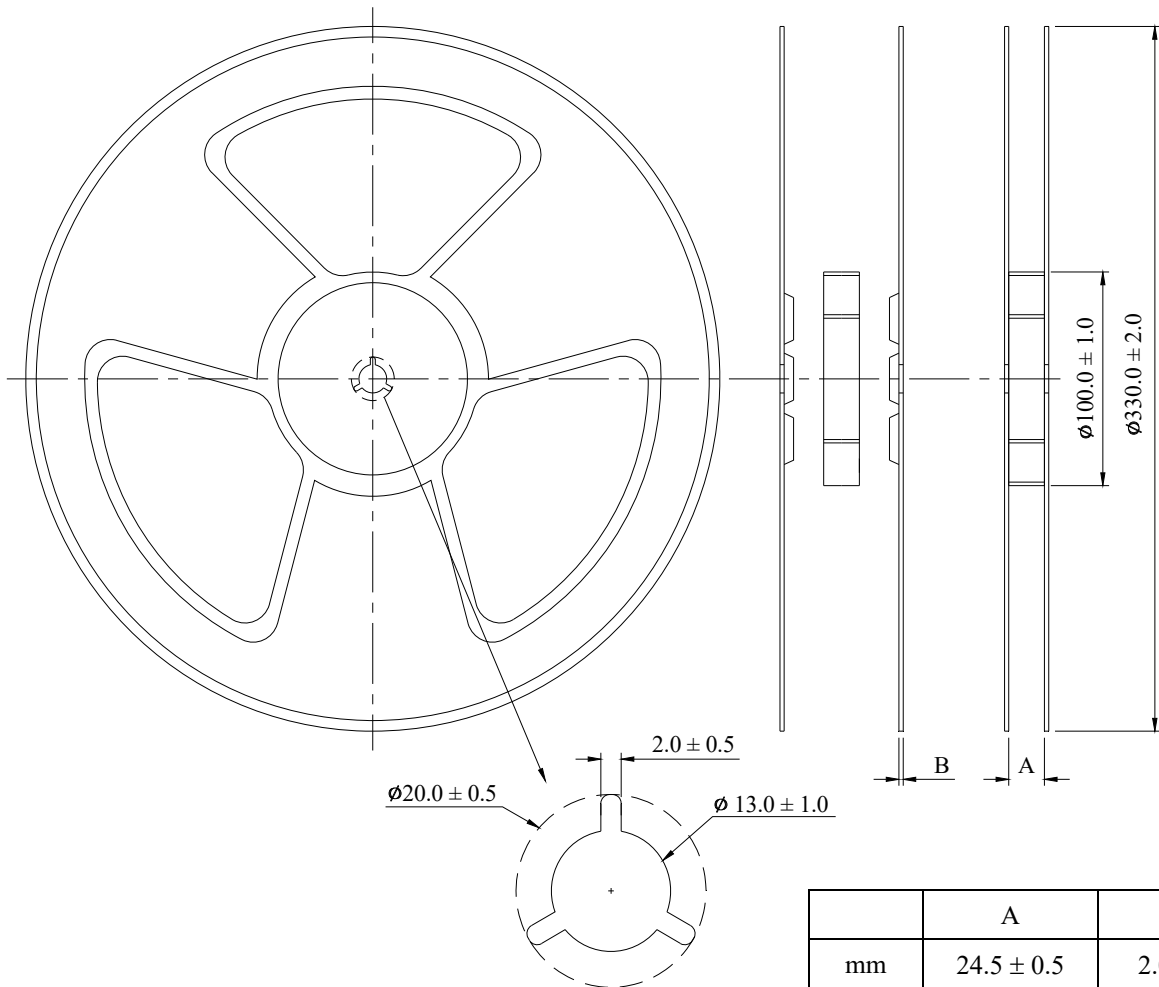

(4) Peel force of top cover tape

The peel speed shall be about 300 mm/minute.

The peel force of top cover tape shall be between 0.1 to 1.3N.

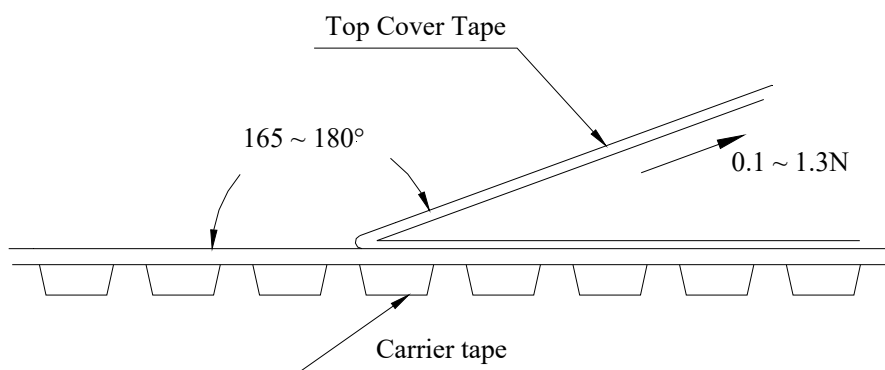

■ Reflow Profile

Power Choke Coil Type

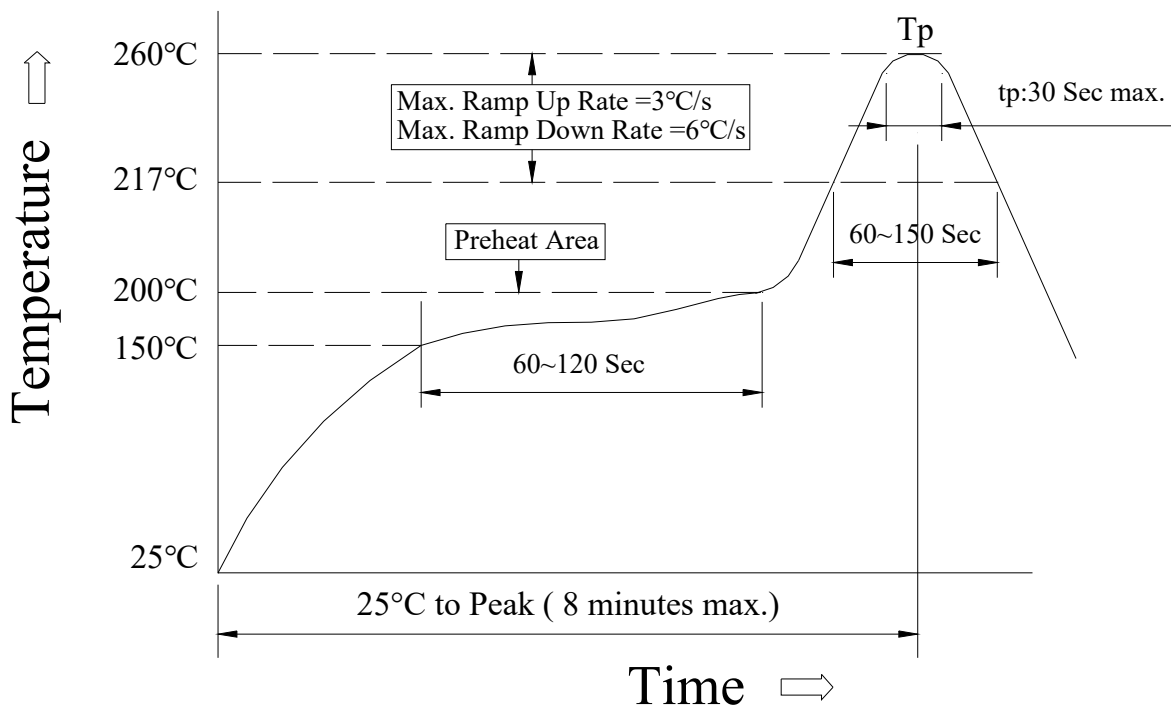

(1) Reflow Soldering Method :

Reflow Soldering	Tp:255~260°C	Max.30 seconds ( tp )
	217°C	60~150 seconds
Pre-Heat	150 ~ 200°C	60~120 seconds
Time 25°C to peak temperature	8 minutes max.	

(2) Soldering iron Method : 350 ± 5°C max.3 seconds