

The history of revision change for the specification

Document	REV.	Modified date	Description
CYNVC-196-053	A0	2019.6.21	New Approval
CYNVC-196-053	A1	2019.9.20	1. Jun. -> Sep. 2. Add spec & curve of 150
CYNVC-196-053	A2	2020.1.22	1. Sep., 2019 -> Jan., 2020 2. Year code: 2019 = 9 -> 2020 = 0 3. Add 2R2, 6R8 spec and curve
CYNVC-196-053	A3	2020.6.15	1. Jan. -> Jun. 2. Add rated voltage
CYNVC-196-053	A4	2020.9.9	1. Jun. -> Sep. 2. Update Land Pattern A: 3.6 -> 3.5 ; B: 2.2 -> 2.05 ; C: 7.2 -> 6.61
CYNVC-196-053	A5	2021.4.6	1. Sep., 2020 -> Apr., 2021 2. Add 4R7 spec and curve
CYNVC-196-053	A6	2023.03.24	1. Apr., 2021 -> Mar., 2023 2. Add spec & curve of 3R3 3. Year code: 2021 = 1 -> 2023 = 3
CYNVC-196-053	A7	2024.09.26	1. Mar., 2023 -> Sep., 2024 2. Add notice 'Shielded construction' in Features 3. Year code: 2023 = 3 -> 2024 = 4 4. Reflow Soldering : 217°C -> $\geq 217^{\circ}\text{C}$

Power Choke Coil VCHA054T MS6 type

AEC-Q200

■ Features

High performance (Isat) realized by metal dust core

Low profile : Thickness 4.0mm Max.

Low loss realized with low DCR

Compliance with RoHS and Halogen Free

Shielded construction

AEC-Q200 qualified

■ Application

Automotive applications

■ Outline Dimensions

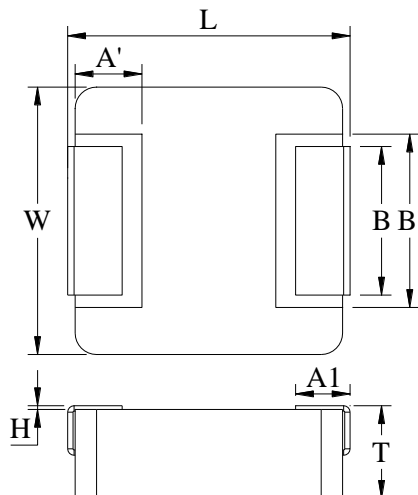

Code	Dimensions (mm)
L	5.40 ± 0.35
W	5.2 ± 0.2
T	3.8 ± 0.2
A1	1.1 ± 0.3
A'	1.5 ± 0.1
B	3.0 ± 0.3
B'	3.5 ± 0.2
H	0 ~ + 0.15

■ Recommend Land Pattern Dimensions

The customer shall determine the land dimensions shown below after confirming and safety.

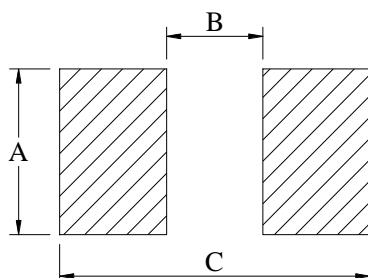

A	3.50
B	2.05
C	6.61

Unit : mm

■ Marking and Date Code

The point on the top surface represents winding direction of choke.

(1) Marking

The inductor is marked with a 3-digit code.

Example -- 22.0 μ H → 220

(2) Date code

X XX

(1) (2)

XXX

(3)

Where (1) Year code

Ex : 2024 = 4

(2) Weekly code

Serial number : 01 ~ 53

(3) Taping no.

Serial number : 001 ~ ZZZ

Upside of Chip

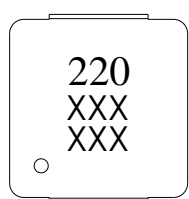

PIN 2

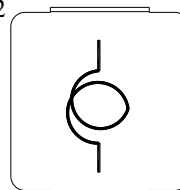

PIN 1

Coil clockwise around

■ Specifications

Part Number	L0 ◇ Inductance (μ H) @ (0A)	R _{dc} ($m\Omega$) ◇		Heat Rating Current DC Amps. Idc (A)		Saturation Current DC Amps. Isat (A)		Rated Voltage (V)
		Typical	Maximum	Typical	Maximum	Typical	Maximum	Maximum
VCHA054T-2R2MS6	2.2	21.8	24.0	6.9	6.2	10.9	9.3	45
VCHA054T-3R3MS6	3.3	26.8	29.5	6.5	5.1	8.8	7.5	45
VCHA054T-4R7MS6	4.7	35.9	39.5	5.0	4.5	7.8	6.7	45
VCHA054T-6R8MS6	6.8	48.0	57.6	4.3	3.9	6.3	5.4	45
VCHA054T-100MS6	10.0	84.0	92.4	3.2	2.9	5.0	4.3	45
VCHA054T-150MS6	15.0	100.0	120.0	2.8	2.5	3.5	3.0	45
VCHA054T-220MS6	22.0	158.0	174.0	2.4	2.2	3.4	2.9	45

◇ : Significant Characteristic

Note 1. : Inductance tolerance $\pm 20\%$

Note 2. : All test data is referenced to 25°C ambient.

Note 3. : Test condition; 100KHz, 1.0Vrms

Note 4. : Idc : DC current (A) that will cause an approximate ΔT of 40°C

Note 5. : Isat : DC current (A) that will cause L0 to drop approximately 30%

Note 6. : Operating temperature range -55°C to +165°C

Note 7. : The part temperature (ambient + temp rise) should not exceed 165°C under the worst case operating conditions. Circuit design, component placement, PCB trace size and thickness, airflow and other cooling provision all affect the part temperature. Part temperature should be verified in the end application.

Note 8. : The rated current as listed is either the saturation current or the heating current depending on which value is lower.

Note 9. : Cleaning process note

(a) If this power choke is dipped in the cleaning agent, such as toluene, xylene, ketone, and ether system, there is a possibility that the performance decreases greatly.

(b) The high power ultrasonic washing may damage the choke body.

(c) Please contact us if you need the cleaning via the above agents or ultrasonic washing.

Note 10. : If you require another part number, please contact with us.

Current Characteristic

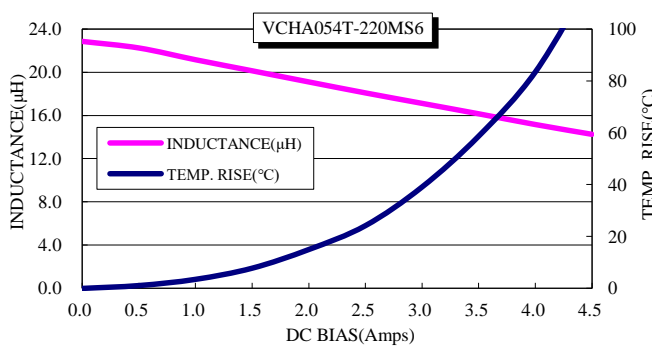
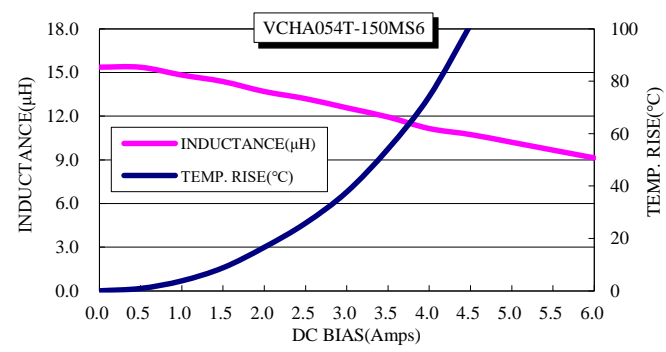
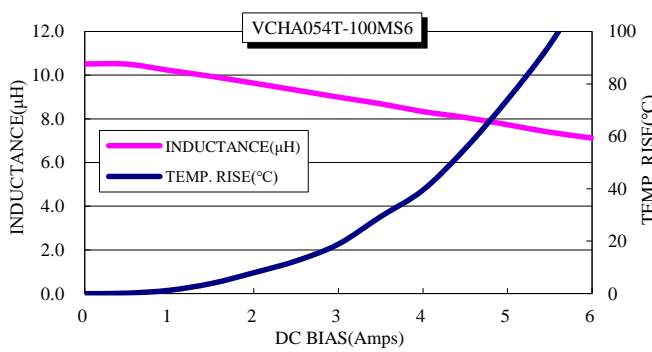
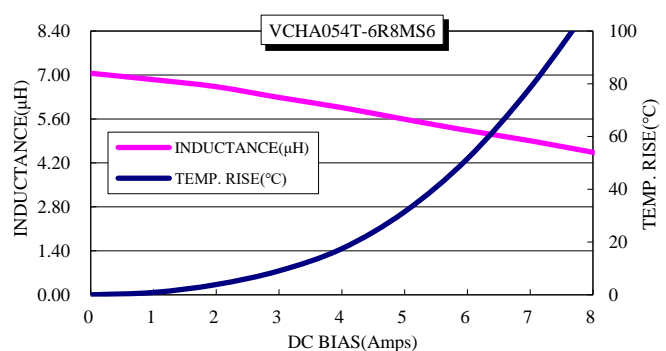
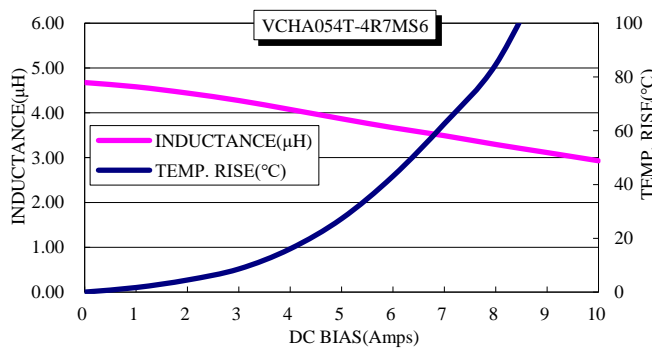
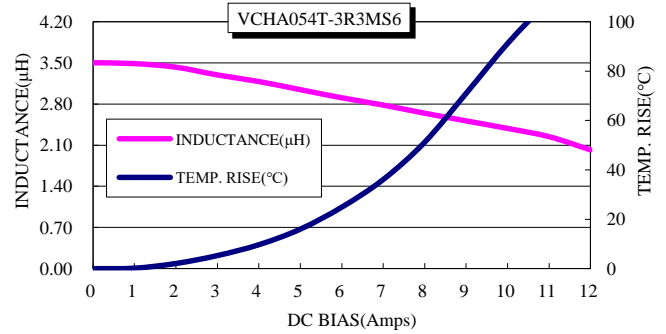
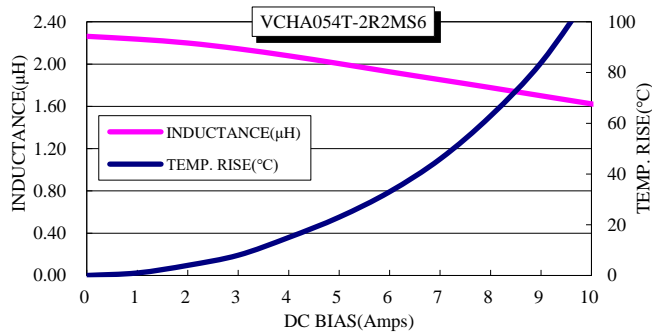

■ Packaging

(1) Tape packaging dimensions

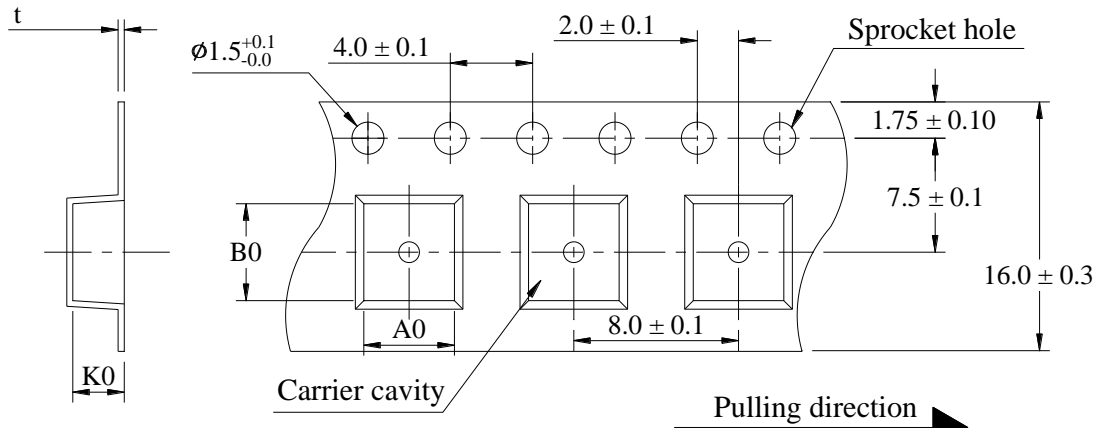

Dimensions Code (mm)				Units/Reel
A0	B0	K0	t	
5.7 ± 0.1	5.9 ± 0.1	4.3 ± 0.1	0.50 ± 0.05	1,000

(2) Tape direction

The direction shall be seen from the top cover tape side.

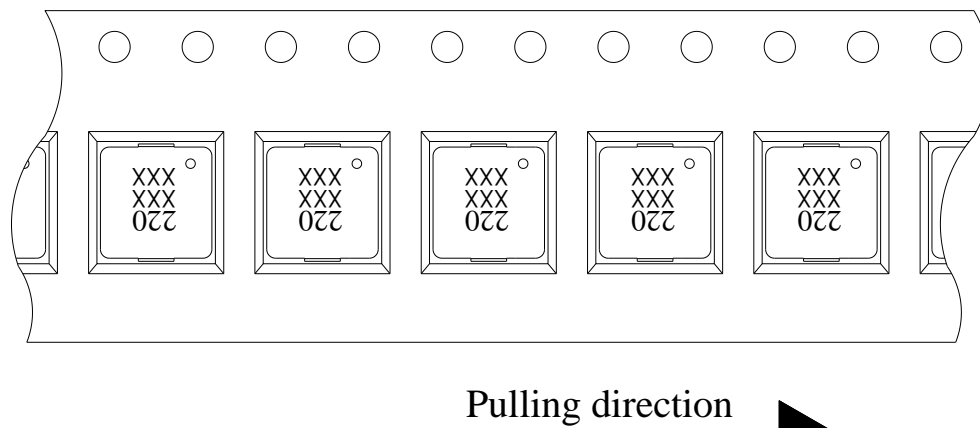

(3) Reel dimensions

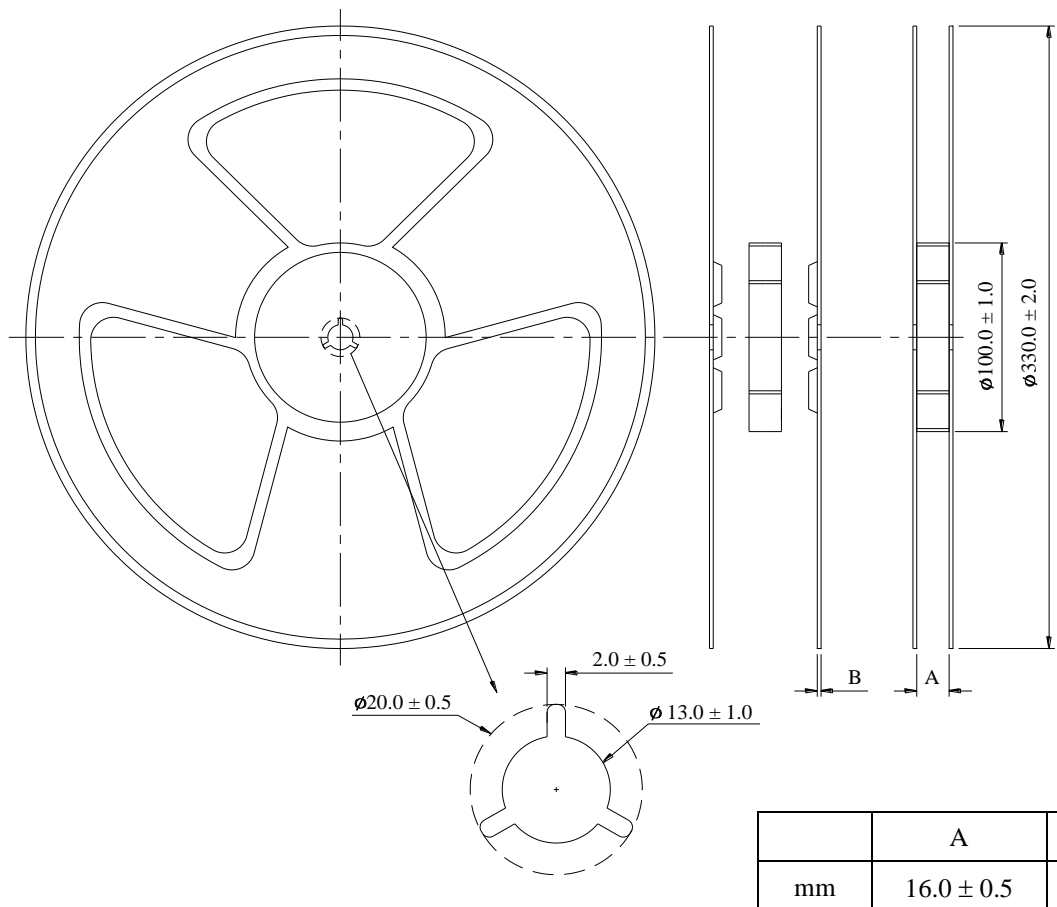

(4) Peel force of top cover tape

The peel speed shall be about 300 mm/minute.

The peel force of top cover tape shall be between 0.1 to 1.3N.

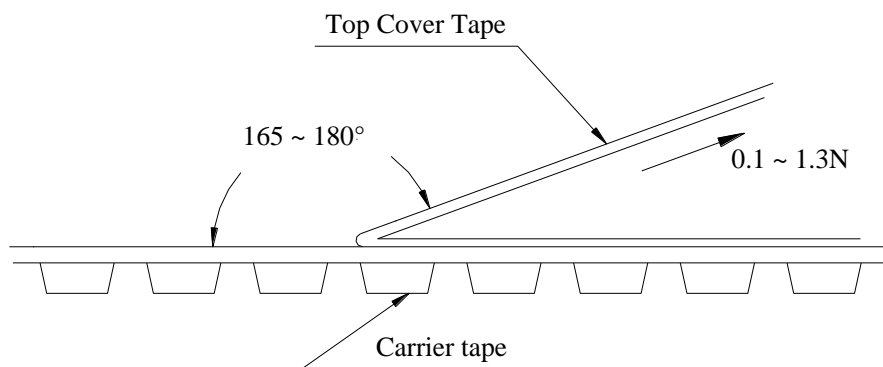

■ Reflow Profile

Power Choke Coil Type

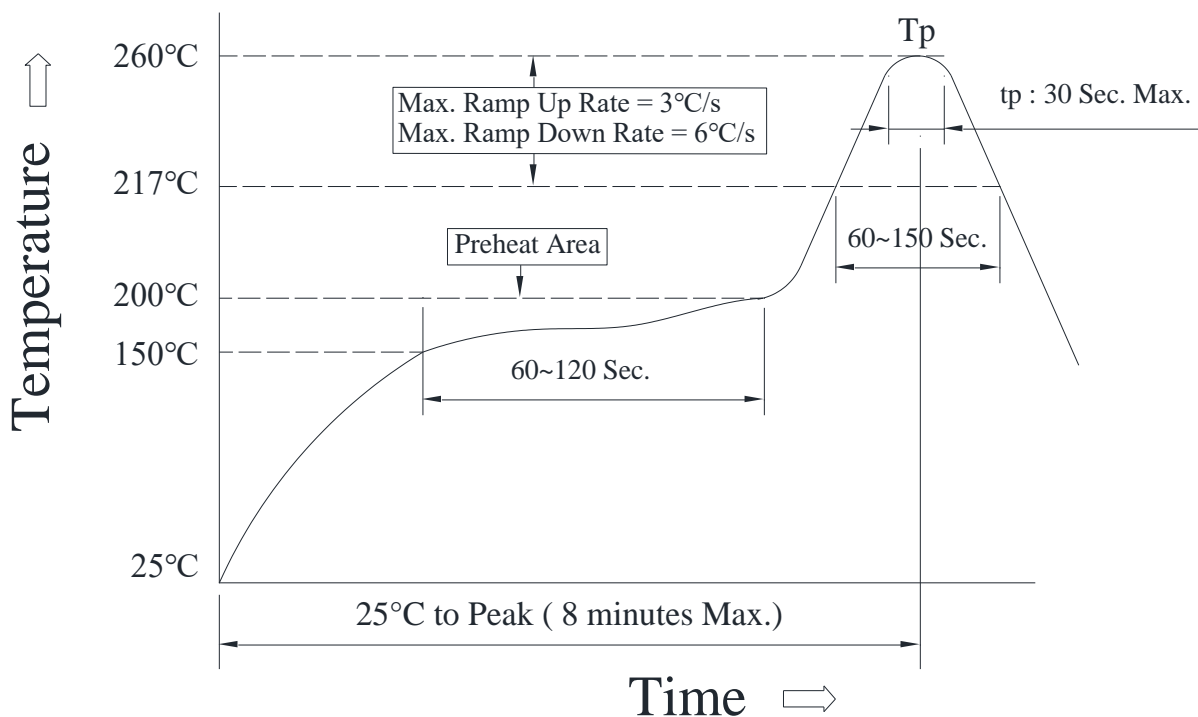

(1) Reflow soldering method :

Reflow Soldering	Tp : 255~260°C	Max. 30 seconds (tp)
	≥ 217°C	60~150 seconds
Preheat	150~200°C	60~120 seconds
Time 25°C to peak temperature	8 minutes Max.	

(2) Soldering iron method : 350 ± 5°C, 3 seconds Max.