

VSRP0805SD Series Current Sensing Resistor (Lead / Halogen Free)

Features / Applications :

- High power rating is up to 1/2W
- Low TCR (± 200 ppm/ $^{\circ}$ C)
- Current sensing resistor for power supplies, motor circuits, etc.
- RoHS compliant & AEC-Q200 qualified
- Suitable for reflow soldering

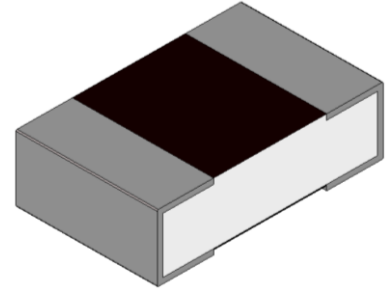

Electrical Specifications :

Characteristics	Feature	
Power Rating*	1/2 W	
Resistance Range	0.020 Ω ~0.150 Ω	0.151 Ω ~0.50 Ω
Temperature Coefficient of Resistance(ppm/ $^{\circ}$ C)	± 200	± 100
Resistance Tolerance	$\pm 1\%$ (F), $\pm 2\%$ (G), $\pm 5\%$ (J)	
Operation Temperature Range	-55° C ~ $+155^{\circ}$ C	

*Note :

For sensor operated at ambient temperature in excess of 70° C, the maximum load shall be derated in accordance with the following curve.

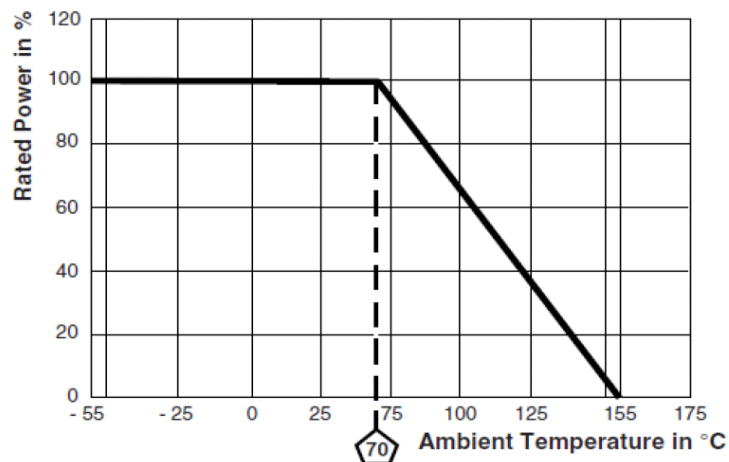

Outline Drawing :

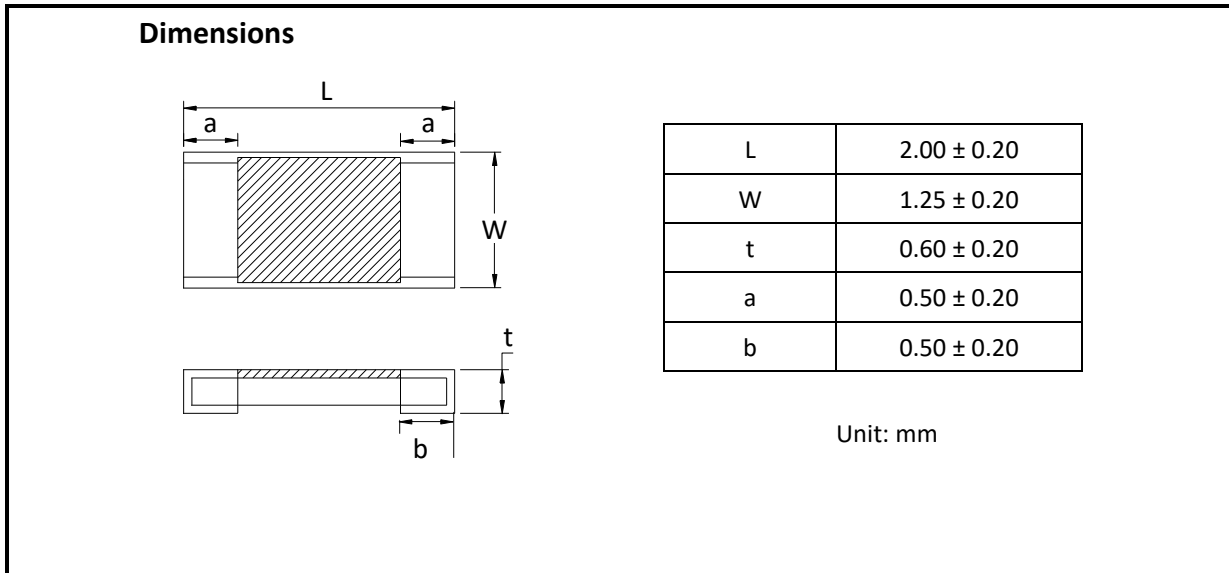

Type Designation :

V S R P 0805 S D - □ □ □ □ □
 (1) (2) (3) (4) - (5) (6)

Note :

(1) Series No.

(2) Size

(3) S= Short terminal type

(4) Power Rating : $D = 1/2W$

(5) Resistance value:

The "R" shall be used as a decimal point, For example --

R020 = 0.02Ω ;

(6) Tolerance (%)

F=±1%, G=±2%, J=±5%

Characteristics :

Electrical

Item	Specification and Requirement	Test Method
Temperature Coefficient of Resistance (TCR)	As electrical specifications	JIS-C-5201 Room temperature Room temperature+100°C
Short Time Overload	$\Delta R: \pm 0.5\%$ Without damage by flashover, spark, arcing, burning or breakdown	JIS-C-5201-1 4.13 2.5 x rated power for 5 seconds.
Insulation Resistance	Over 100 M Ω on Overcoat layer face up Over 1,000 M Ω on Substrate side face up	JIS-C-5201-1 4.6 100V _{DC} for 60 +10/-0 seconds.
Voltage Proof	$\Delta R: \pm 1.0\%$ Without damage by flashover, spark, arcing, burning or breakdown	JIS-C-5201-1 4.7 400V _{AC} (rms.) for 60 +10/-0 seconds.
ESD	$\Delta R: \pm 1.0\%$	AEC-Q200-002 Human body, 3KV.

Mechanical

Item	Specification and Requirement	Test Method
Solderability	The surface of terminal immersed shall be minimum of 95% covered with a new coating of solder	JIS-C-5201-1 4.17 245 \pm 5°C for 3 \pm 0.5 seconds.
Resistance to Solder Heat	$\Delta R: \pm 1.0\%$ Without distinct deformation in appearance	JIS-C-5201-1 4.18 260 \pm 5°C for 10 \pm 1 seconds.
Bending Test	$\Delta R: \pm 1.0\%$ Without mechanical damage such as break	AEC-Q200-005 Bending value: 2 mm for 60 \pm 1 seconds.
Resistance to solvent	Without mechanical and distinct damage in appearance	MIL-STD-202 Method 215 Add Aqueous wash chemical- OKEM Clean or equivalent. Do not use banned solvents.

Item	Specification and Requirement	Test Method
Vibration	$\Delta R: \pm 0.5\%$ Without mechanical damage such as break	MIL-STD-202 Method 204 5g's for 20 minutes, 12 cycles each of 3 orientations. Test from 10-2000Hz.
Mechanical Shock	$\Delta R: \pm 0.5\%$ Without mechanical damage such as break	MIL-STD-202 Method 213 100g's peak value, 6ms, Half-sine waveform, 12.3ft/sec.
Terminal Strength (SMD)	No visible damage	JIS-C-5201-1 Force of 1.8Kg for 60 seconds.

Endurance

Item	Specification and Requirement	Test Method
Temperature Cycling	$\Delta R: \pm 1.0\%$ Without distinct damage in appearance	MIL-STD-002 Method 107 1000 cycles, (-55°C~125°C) 30min maximum dwell time at each temperature.
Biased Humidity	$\Delta R: \pm 1.0\%$	MIL-STD-202 Method 103 1000 hours, 85°C/85%R.H, applied for 10% rated power Measurement at 24 ± 4 hours after test conclusion.
Damp heat, steady state	$\Delta R: \pm 1.0\%$	IEC 60068-2 (40 ± 2) °C; (93 ± 3) % RH;56 days.
Load Life	$\Delta R: \pm 2.0\%$ Without distinct damage in appearance	MIL-STD-202 Method 108 70°C, applied for 100% rated power 1.5 Hour ON, 0.5 Hour OFF For total 1000 hours.
High Temperature Store	$\Delta R: \pm 1.0\%$ Without distinct damage in appearance	MIL-STD-202 Method 108 155°C for total 1,000 hours.

Note : Measurement at 24±4 hours after test conclusion for all reliability tests-parts.

Recommend Land Pattern Dimensions :

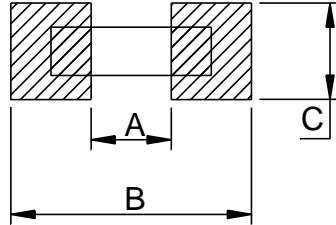

Size	A (mm)	B (mm)	C (mm)	t (mm)
1220	0.6	2.80	1.40	0.105

t: Copper foil minimum thickness of PCB

Packaging :

Tape packaging dimensions

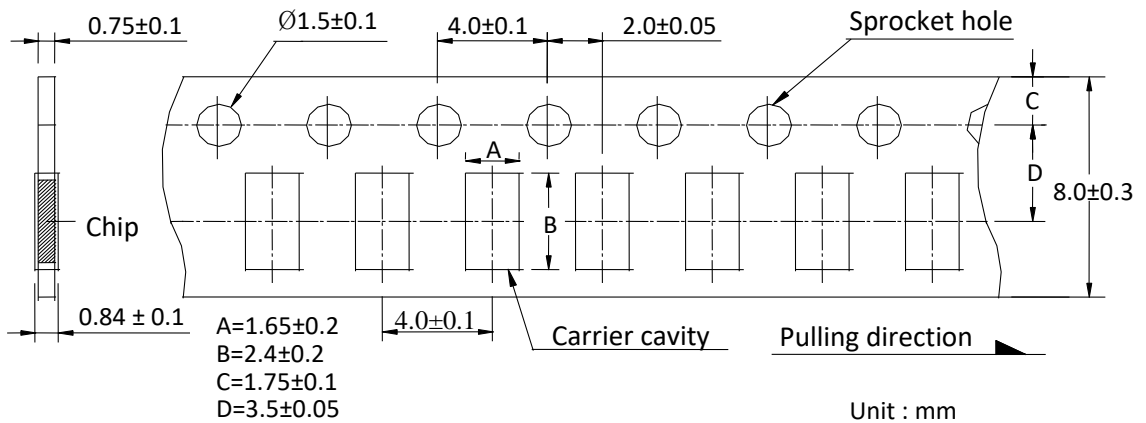

Remark: Leader tape length ≥ 30 cm (150 Hollow carrier cavity)

Reel dimensions

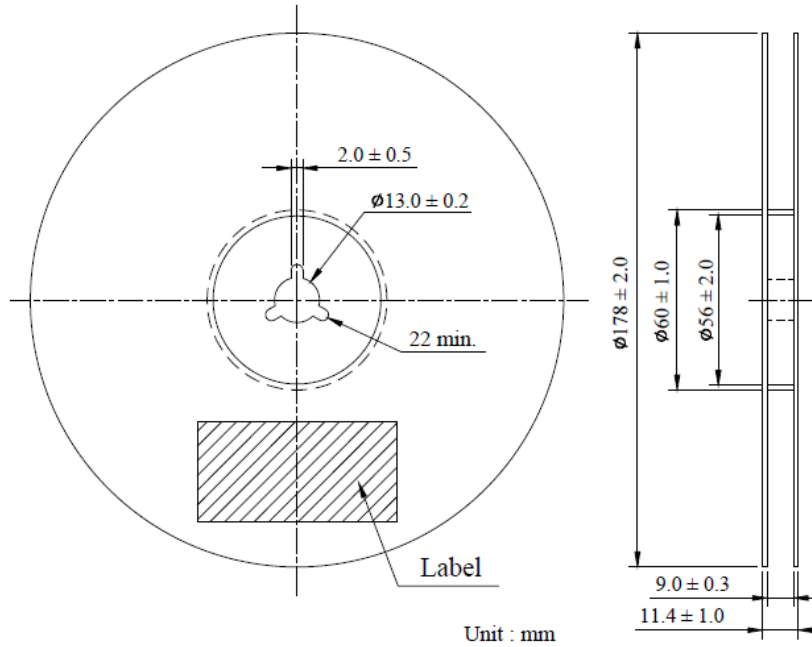

Numbers of Taping : 5,000 pieces /reel

The following items shall be marked on the reel.

- (1) Type designation.
- (2) Quantity
- (3) Manufacturing date code
- (4) Manufacturer's name

Peel force of top cover tape

The peel speed shall be about 300 mm/min. The peel force of top cover tape shall be between 0.1 to 0.7 N.

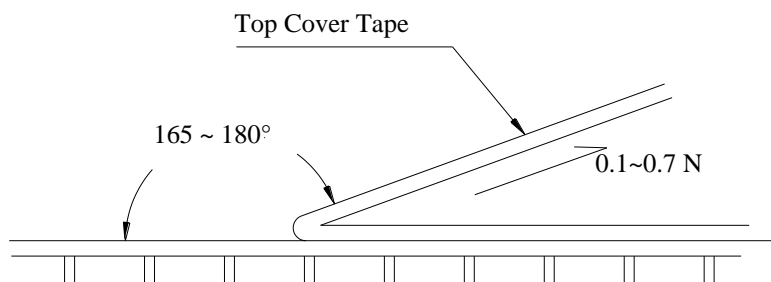

Care Note :

Care note for storage

- (1) Chip resistor shall be stored in a room where temperature and humidity must be controlled.
(temperature 5 to 35°C, humidity 45 to 85% RH) However, a humidity keep it low, as it is possible.
- (2) Chip resistor shall be stored as direct sunshine doesn't hit on it.
- (3) Chip resistor shall be stored with no moisture, dust, a material that will make solderability inferior, and a harmful gas (Chloridation hydrogen, sulfurous acid gas, and sulfuration hydrogen).

Care note for operating and handling

- (1) It is necessary to protect the edge and protection coat of resistors from mechanical stress.
- (2) Handle with care when printing circuit board (PCB) is divided or fixed on support body, because bending of printing circuit board (PCB) mounting will make mechanical stress for resistors.
- (3) Resistors shall be used with in rated range shown in specification. Especially, if voltage more than specified value will be loaded to resistor, there is a case it will make damage for machine because of temperature rise depending on generating of heat, and increase resistance value or breaks.
- (4) In case that resistor is loaded a rated voltage, it is necessary to confirms temperature of a resistor and to reduce a load power according to load reduction curve, because a temperature rise of a resistor depends on influence of heat from mounting density and neighboring element.
- (5) Observe Limiting element voltage and maximum overload voltage specified in each specification
- (6) If there is possibility that a large voltage (pulse voltage, shock voltage) charge to resistor, it is necessary that operating condition shall be set up before use.